

Gradual starter

**AM-52**  
Gradual starter G1/8 ÷ G1



With manual regulation

Model	Connection	Ø mm
AM-5240	G1/8	6,5
AM-5241	G1/4	6,5
AM-5242	G1/4	9,5
AM-5243	G3/8	9,5

With electrical switch

Model	Connection	Ø mm
AM-5242E	G1/8	9,5
AM-5243E	G3/8	9,5



With manual regulation

Model	Connection	Ø mm
AM-5254	G1/2	15
AM-5255	G3/4	15
AM-5256	G 1	24

With electrical switch

Model	Connection	Ø mm
AM-5259	G1/2	15
AM-5260	G3/4	15
AM-5261	G 1	24

Economizer

**AM-53**  
Economizer G1/8 ÷ G1



Model	Connection	Ø mm
AM-5350	G1/8	6,5
AM-5351	G1/4	6,5
AM-5352	G1/4	9,5
AM-5353	G3/8	9,5
AM-5354	G1/2	15
AM-5355	G3/4	15
AM-5356	G 1	24

Check valve

**AM-54**  
Check valve G1/2 - G3/4 - G1



Model	Connection	Ø mm
AM-5400	G1/2	15
AM-5401	G3/4	15
AM-5402	G 1	24

Blocking valve

**AM-55**  
Blocking valve



Model	Connection	Ø mm
AM-5500	G1/8	6,5
AM-5501	G1/4	6,5
AM-5502	G1/4	9,5
AM-5503	G3/8	9,5
AM-5504	G1/2	15

One-way

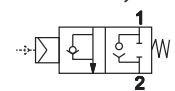

Model	Connection	Ø mm
AM-5510	G1/8	6,5
AM-5511	G1/4	6,5
AM-5512	G1/4	9,5
AM-5513	G3/8	9,5
AM-5514	G1/2	15

Two-way

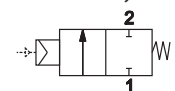

Transducer and pressure switch

**AM-5200**  
Pneumo-electrical transducer

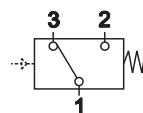
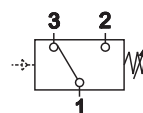
AM-5200

**AM-5220**  
Adjustable pressure switch

AM-5220